

# Float Office



# Float Office

**2**

Float Office

**7**

Solo

**13**

Bench

**21**

Operative

**29**

Executive

**35**

Reception

**44**

Finishes

**46**

Components

**Un sistema completo e sinergico per un ambiente lavorativo contemporaneo e funzionale.**

**In questo catalogo presentiamo un contributo ragionato al mondo professionale, capace di sviluppare sistemi di arredo per spazi e utilizzi diversi.**

**Le molteplici singolarità di Float Office si compongono a formare un'unica e completa entità.**

**Il mondo del lavoro necessita di versatilità e di possibilità di scelta, richiede prodotti che sappiano dare risposta alle esigenze di chi lavora, sviluppandone comfort e migliorandone l'efficienza.**

## Float Office

A complete and synergistic system for a contemporary and functional working environment.

In this catalogue, we present a reasoned contribution to the professional world, capable of developing furnishing systems for different spaces and uses.

The many unique features of Float Office are combined to form a unique and complete entity.

The workplace needs versatile solutions and possibility of choice. It requires products that can respond to the needs of those who work, developing comfort and improving their efficiency.

Un système complet et synergique pour un environnement de travail contemporain et fonctionnel.

Dans ce catalogue, nous présentons une contribution raisonnée au monde professionnel, capable de développer des systèmes d'ameublement pour différents espaces et usages.

Les nombreuses caractéristiques de Float Office sont combinées pour former une entité unique et complète.

Le monde du travail a besoin de solutions et de choix polyvalents, il exige des produits qui peuvent répondre aux besoins de ceux qui travaillent, en développant le confort et en améliorant l'efficacité.

Un sistema completo y de sinergia para un ambiente de trabajo contemporáneo y funcional.

En este catálogo presentamos una aportación pensada para el mundo profesional, capaz de desarrollar sistemas de mobiliario para espacios y utilizaciones diversas.

Las múltiples singularidades de Float Office se integran y forman una única y completa entidad.

El mundo del trabajo necesita soluciones versátiles y con posibilidades de elección, reclama productos que sepan dar respuesta a las exigencias de quien trabaja, desarrollando confort y mejorando la eficiencia.

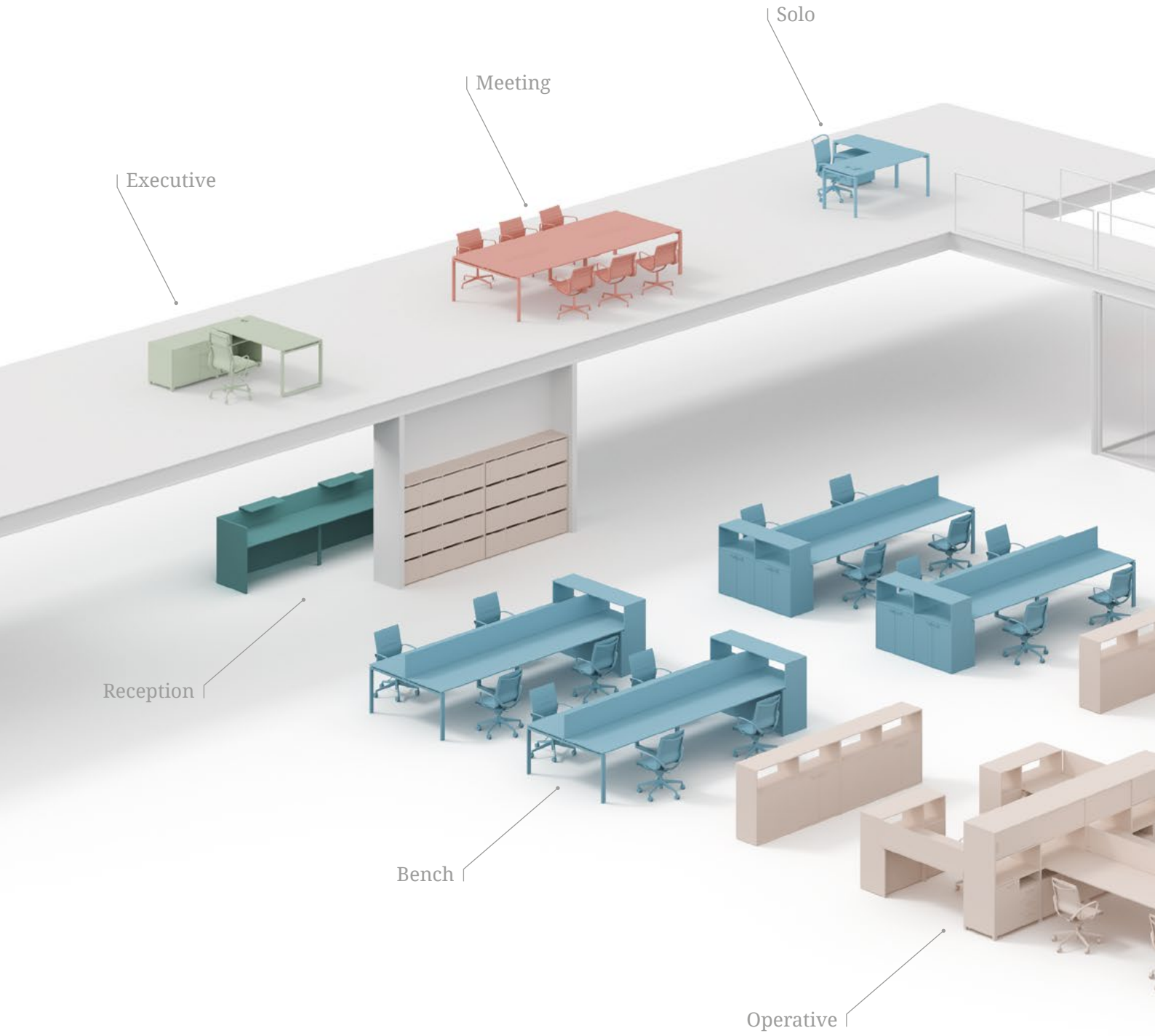

# Float Office



archiutti

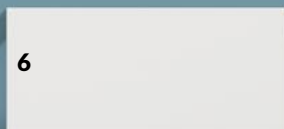
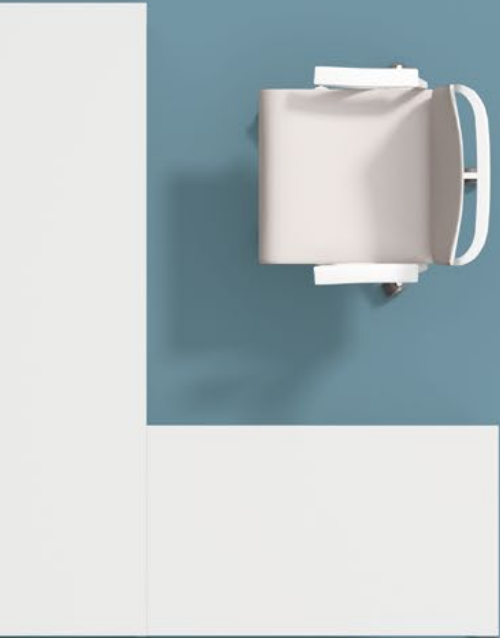
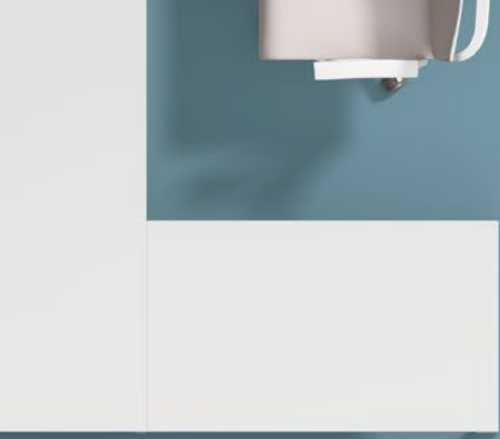



# Solo

---



La scrivania Float Office è adattabile a qualsiasi tipologia di ambiente grazie a linee essenziali e pulite. Dispone di una struttura regolabile in altezza ed è dotata di piani di lavoro scorrevoli per un agevole accesso ai cavi.

The Float Office desk is adaptable to any type of environment thanks to its clean and essential lines. It has a height adjustable structure and is equipped with sliding worktops for easy access to cables.

Le bureau Float Office s'adapte à tout type d'environnement grâce à ses lignes épurées et essentielles. Il possède une structure réglable en hauteur et est équipé de plans de travail coulissants pour faciliter l'accès aux câbles.

El escritorio Float Office se adapta a cualquier tipología de ambiente gracias a sus líneas esenciales y limpias. Dispone de una estructura regulable en altura y esta provisto de planos de trabajo deslizantes para facilitar el acceso al cableado.



Float Office





Scrivania operativa con allungo laterale tutto in melaminico bianco; struttura a cavalletto in metallo verniciato a polvere in tinta. Completano cassettera a 3 cassetti e librerie altezza 270 cm ad anta intera.

Operative desk with side extension, all in white melamine; matching trestle structure in powder-coated metal. Complete 3-drawer pedestal and 270 cm height bookcases with full height door.

Bureau avec retour tout en mélamine blanche; structure à tréteaux en métal peint par poudrage de la même couleur. Complet avec un caisson à 3 tiroirs et des bibliothèques à portes pleines de 270 cm de hauteur.

Escritorio operativo con ala lateral totalmente en melamina blanca, estructura metálica pintada en epoxy en polvo tintada. Completan la composición una cajonera de 3 cajones y un armario de altura 270 cm con puertas enteras.

## Float Office

Cassettiera a tre cassetti con serratura  
Three drawers pedestal with lock  
Caisson à trois tiroirs avec serrure  
Cajonera de tres cajones con cerradura



Scrivania elevabile da 65 a 85 cm  
Height adjustable desk form 65 to 85 cm  
Bureau avec réglage de la hauteur de 65 à 85 cm  
Escritorio ajustable en altura de 65 a 85 cm

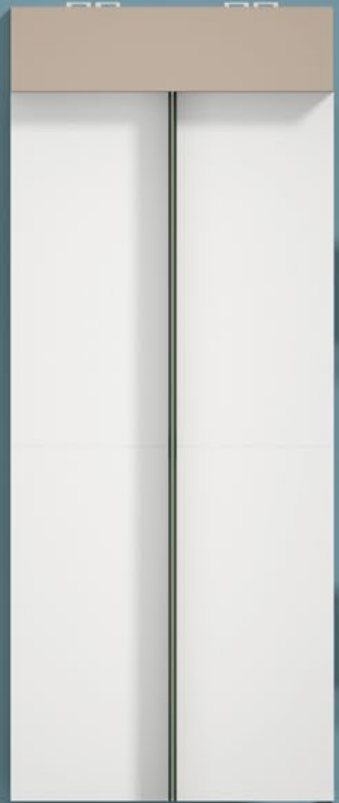
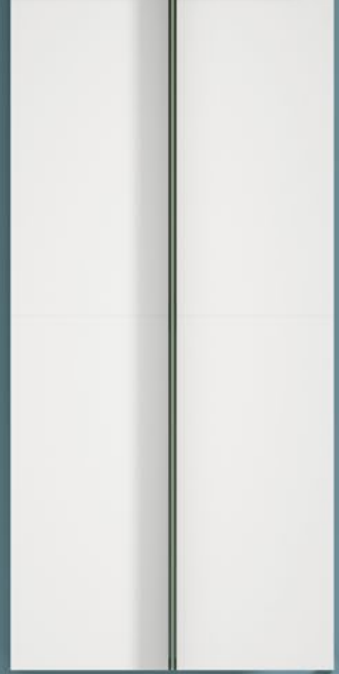

# Bench



Molteplici postazioni si compongono ottenendo luoghi di lavoro condivisi che ottimizzano lo spazio e l'interazione. Grazie agli screen in tessuto è possibile definire lo spazio personale in un luogo progettato per il coworking.

Multiple workstations are composed thus obtaining shared workplaces that optimize space and interaction. Thanks to the fabric screen you can define your personal space in a place designed for coworking.

Des postes de travail multiples sont constitués pour créer des lieux de travail partagés qui optimisent l'espace et l'interaction. Grâce aux panneaux en tissu, il est possible de définir l'espace personnel dans un lieu conçu pour le coworking.

Se pueden efectuar diversidad de composiciones obteniendo puestos de trabajo compartidos que optimizan el espacio y la interacción. Gracias a los paneles divisorios tapizados es posible definir el espacio personal en un lugar proyectado para el Coworking.







Bench con piani di lavoro in melaminico e struttura in metallo verniciato. Completano cassettiere e screen in tessuto. Sul fondo lockers con ante color tortora, verde e bianco.

Bench with worktops in melamine and painted metal structure. Complete with pedestals and fabric screen. In the background lockers with dove grey, green and white colored doors.

Bench avec plans de travail en mélamine et structure en métal peint. Complet avec caissons et panneaux en tissu. Casiers avec portes couleur tourterelle, vertes et blanches sur la paroi arrière.

Composiciones de bench con planos de trabajo de melamina y estructura metálica pintada. Completo con cajones y paneles divisorios tapizados. En el fondo, armarios con puertas de color grises tórtola, verdes y blancas.



Dettaglio del piano di lavoro con torretta portaprese a scomparsa e pannello divisorio in tessuto.

Detail of the work top with concealed sockets turret and fabric partition panel.

Détail du plan de travail avec tourelle de prises rétractable et panneau de séparation en tissu.

Detalle del plano de trabajo con la torreta portacables escamoteable y panel divisorio tapizado.

Float Office







Composizioni di bench con piano tortora e struttura bianca ad anello aggregati a librerie in melaminico tortora. A sinistra, un tavolo riunione 160 x 164 cm con piano verde e gamba bianca con passacavi rettangolare.

Bench compositions with dove grey top and white closed ring leg combined with dove grey melamine bookcases. On the left, a 160 x 164 cm meeting table with green top and white leg with square rectangular cable port.

Compositions de bench avec plateaux en mélamine tourterelle et structure blanche avec pieds anneau agrégés à des bibliothèques en mélamine tourterelle. À gauche, une table de réunion de 160 x 164 cm avec plateau vert et structure blanche avec top access rectangulaire.

Composiciones de Bench con mesa gris tórtola y pata cerrada blanca unida a librería en melamina gris tórtola. A la izquierda una mesa de reuniones 160x 164 cm planos de trabajo verde y pata blanca con pasacables rectangular.



# Operative

---



Il sistema Float Office permette di sviluppare sistemi modulari e componibili, dove le singole scrivanie unite a librerie e cassettiere creano postazioni di lavoro personali all'interno di un ambiente comune. L'alternanza di vani a giorno e contenitori consente di creare isole di lavoro flessibili e adattabili a molteplici esigenze.

The Float Office range makes it possible to develop modular and composed systems where the individual desks combined with bookcases and pedestals create personal work spaces within a common environment. The alternation of open compartments and containers allows to create flexible work islands which can be adapted to a variety of needs.

Le système Float Office permet de développer des systèmes modulaires, où des bureaux individuels combinés avec des bibliothèques et des caissons créent des postes de travail personnels dans un environnement commun. L'alternance de compartiments ouverts et fermés permet de créer des îlots de travail flexibles qui peuvent être adaptés à de multiples besoins.

El sistema Float Office permite desarrollar sistemas modulares y componibles en los cuales el escritorio unido a la librería y cajonera crean puestos de trabajo personales en el interior de un ambiente común. La alternancia de huecos y armarios permiten crear islas de trabajo flexibles y adaptables a múltiples exigencias.





Float Office





Composizioni di contenitori variamente attrezzati con scrivanie in melaminico completate da screen in tessuto e cuscini.

Compositions of variously equipped containers with melamine finished desks completed with fabric screen and cushions.

Compositions d'armoires diversement équipés avec bureaux en mélamine complétés par des panneaux en tissu et des coussins.

Composiciones de armarios de varias tipologías, con escritorio en melamina completados con paneles divisorios tapizados y cojines.





# Float Office





# Executive

---



L'accostamento di finiture e materiali eleganti, come il noce canaletto e l'antracite, unito alla struttura ad anello della scrivania, valorizza la composizione rendendola adatta all'ambiente direzionale. Il piano di lavoro è in appoggio al mobile di servizio con ante e cassetti.

The combination of elegant finishes and materials, such as American Walnut and anthracite, combined with the closed ring structure of the desk, enhances the composition making it suitable for the executive environment. The worktop is supported by the service unit which is equipped with doors and drawers.

La combinaison de finitions et de matériaux élégants, tels que le Noyer américain et l'antracite, associée à la structure en anneau du bureau, met en valeur la composition, ce qui la rend adaptée à l'environnement directionnel. Le plan de travail repose sur meuble de service avec portes et tiroirs.

La unión de acabados y materiales elegantes, como el Nogal Americano y antracita, junto con la estructura cerrada del escritorio dan valor a la composición haciéndola adecuada para un ambiente direccional. El plano de trabajo se apoya sobre el mueble de servicio con puertas o cajones.









## Float Office



Scrivania con piano in melaminico canaletto e struttura ad anello antracite. Il mobile in appoggio riprende le medesime finiture.

Desk with in American Walnut melamine top and anthracite closed ring structure. The cabinet in support incorporates the same finishes.

Bureau avec plateau en mélamine Noyer américain et structure anneau anthracite. L'élément de soutien a les mêmes finitions.

Escritorio con sobre en melamina, color Nogal Americano y estructura cerrada antracita. El mueble de apoyo tiene el mismo acabado.

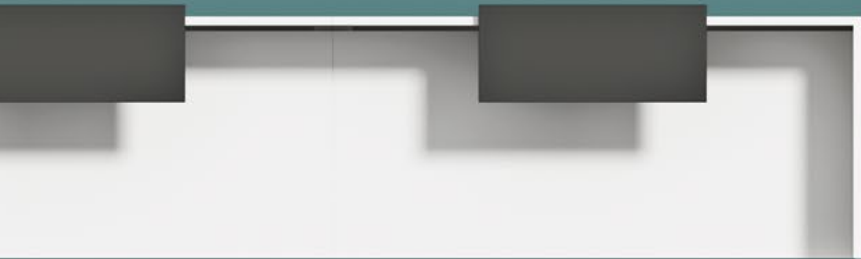
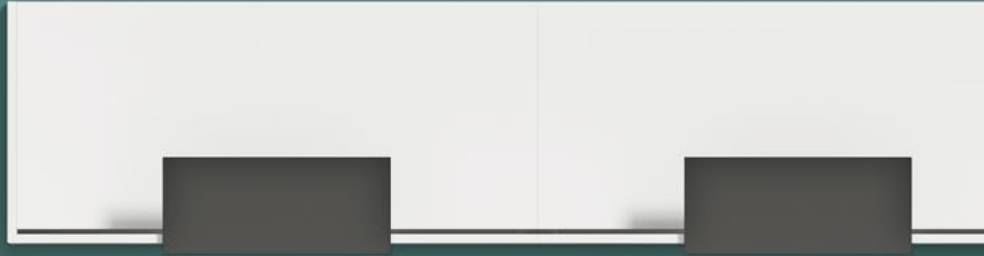

# Reception

---

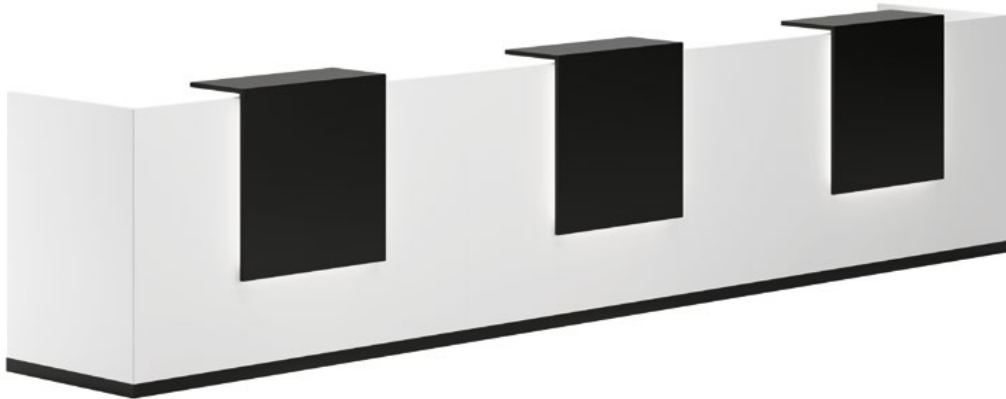

I moduli che compongono la reception consentono numerose declinazioni dello spazio di accoglienza, disponibili in diverse dimensioni e finiture per un ambiente di lavoro ordinato, funzionale e raffinato.

The modules that make up the reception area allow for numerous variations of the welcoming space. These are available in different sizes and finishes for a tidy, functional and refine work environment.

Les modules qui composent la réception permettent de nombreuses variantes de l'espace d'accueil, disponibles en différentes tailles et finitions pour un environnement de travail ordonné, fonctionnel et raffiné.

Los modelos que forman la recepción permiten numerosas variaciones del espacio de acogida, disponibles en diversas dimensiones y acabados para un ambiente de trabajo ordenado, funcional y refinado.



Reception lineare  
composta da tre  
moduli in melaminico  
noce canaletto e  
pannelli bianchi dotati  
di barre led per la  
retroilluminazione.

Linear reception  
composed by three  
modules in American  
Walnut melamine and  
white colored panels  
lighted by LEDs.

Réception linéaire  
composée de trois  
modules en mélamine  
Noyer Amérique et  
panneaux blancs avec  
éclairage LED.

Recepción linear  
compuesta de tres  
módulos de melamina  
Nogal Americano y  
paneles antracita con  
iluminación LED.









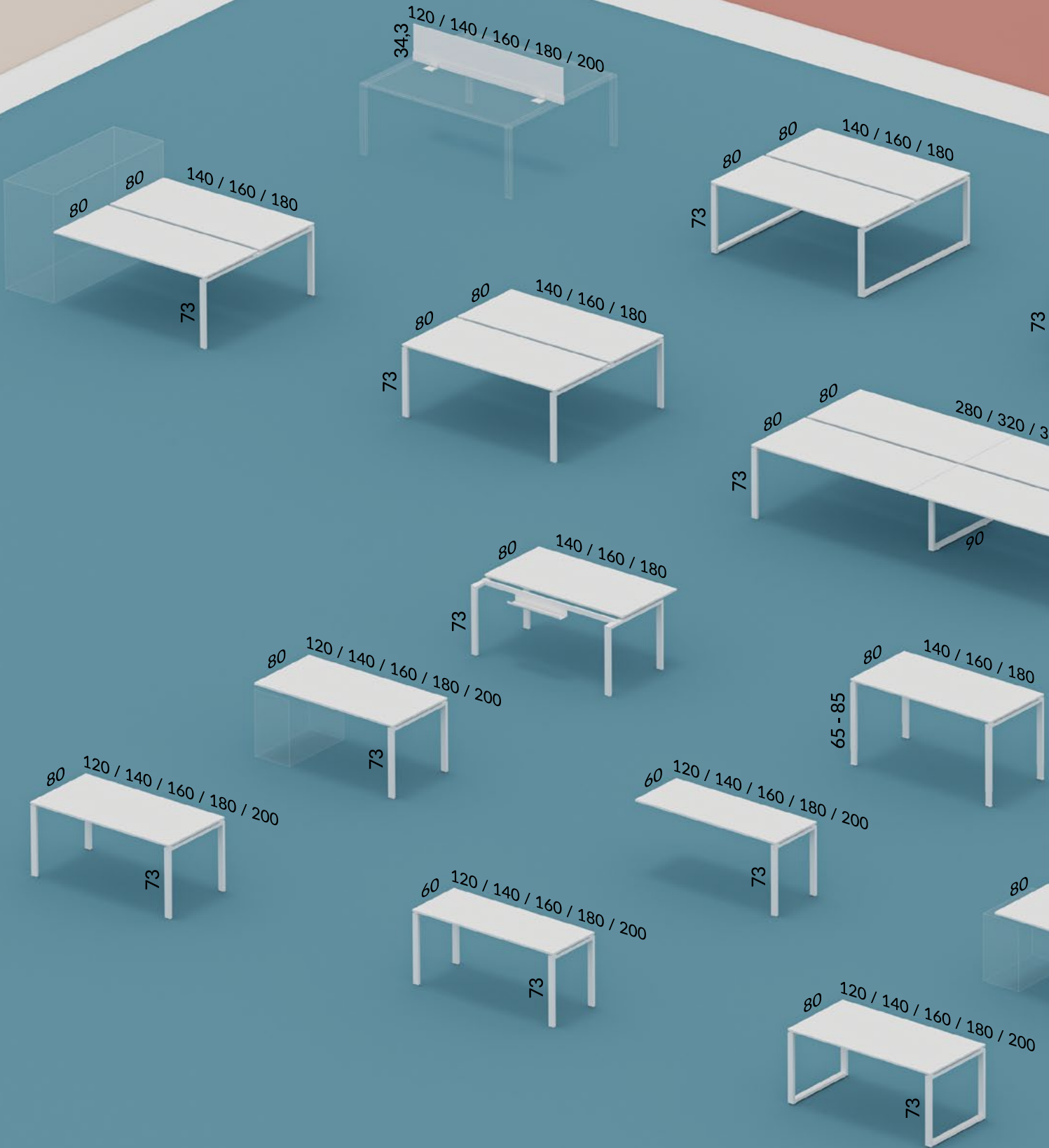

# Float Office

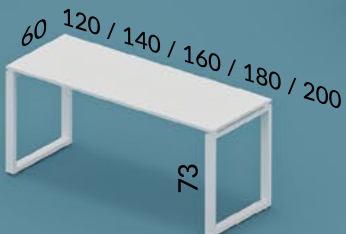
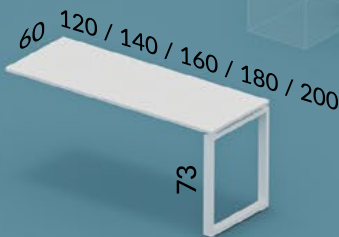
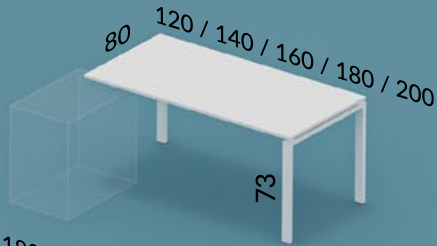
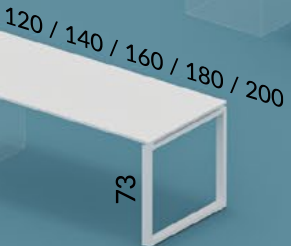
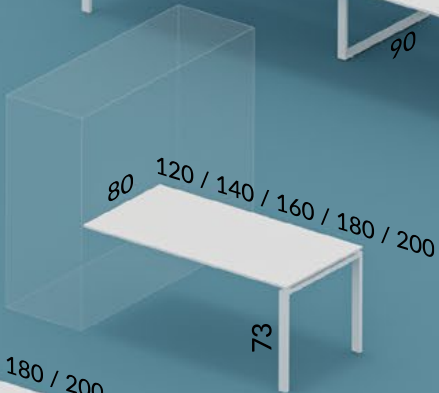
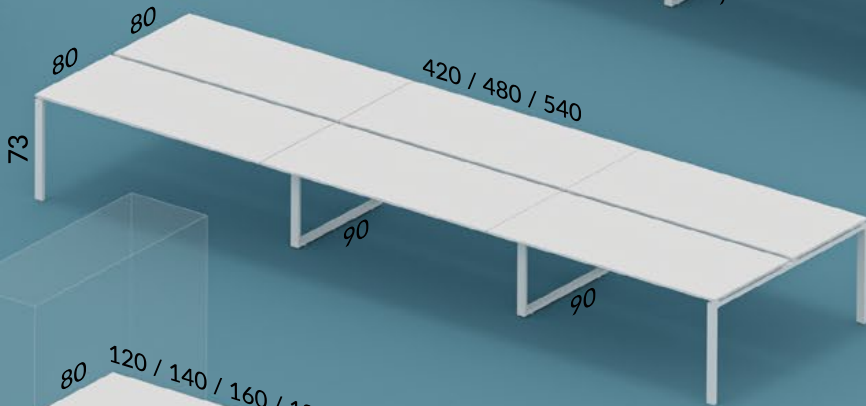
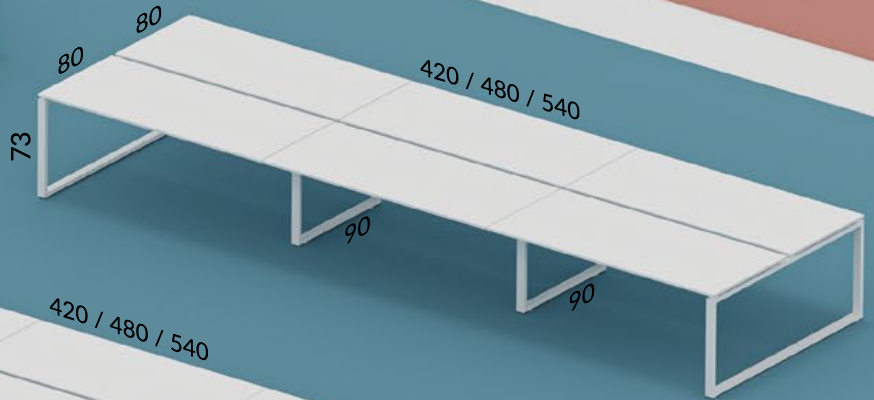
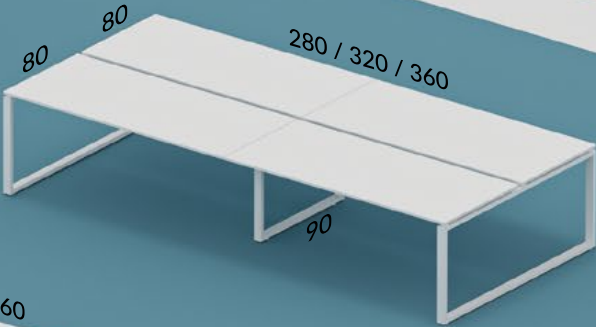
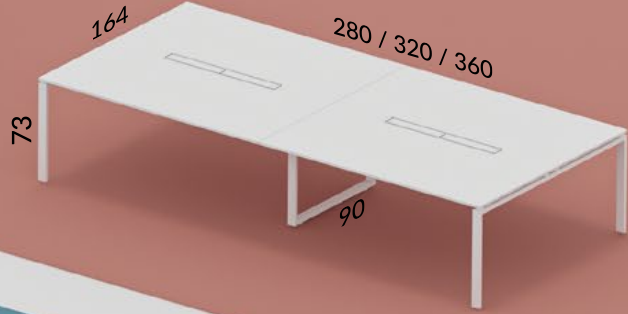
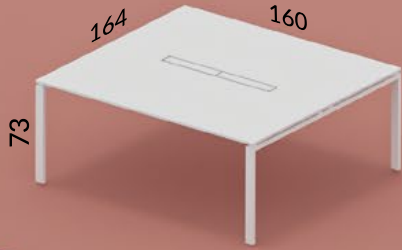

archiutti

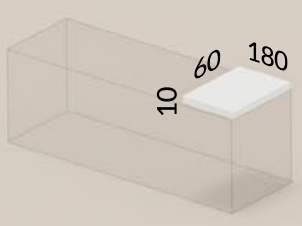
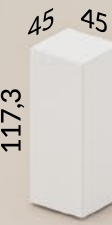
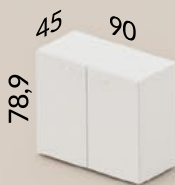
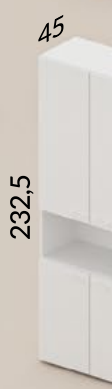
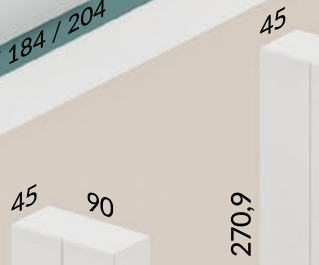
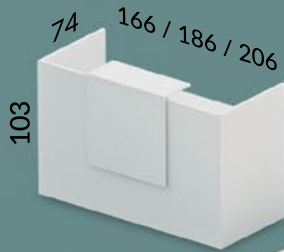
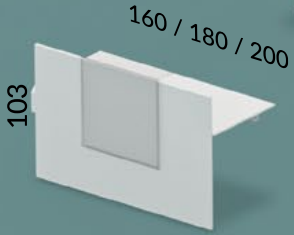
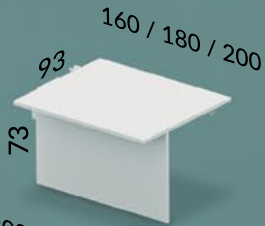
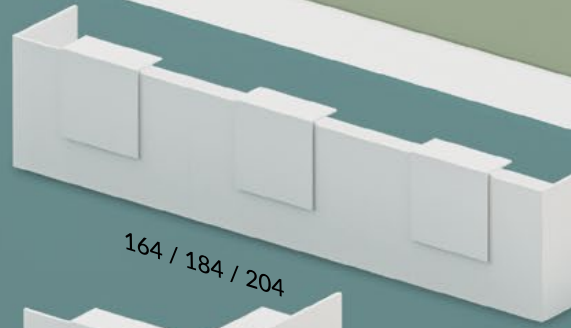
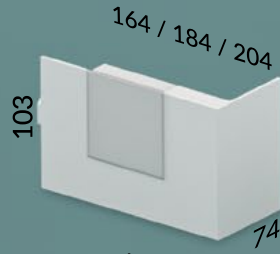
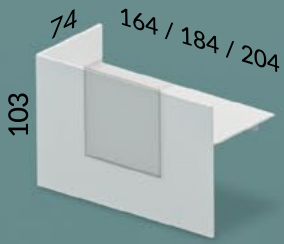

Float Office

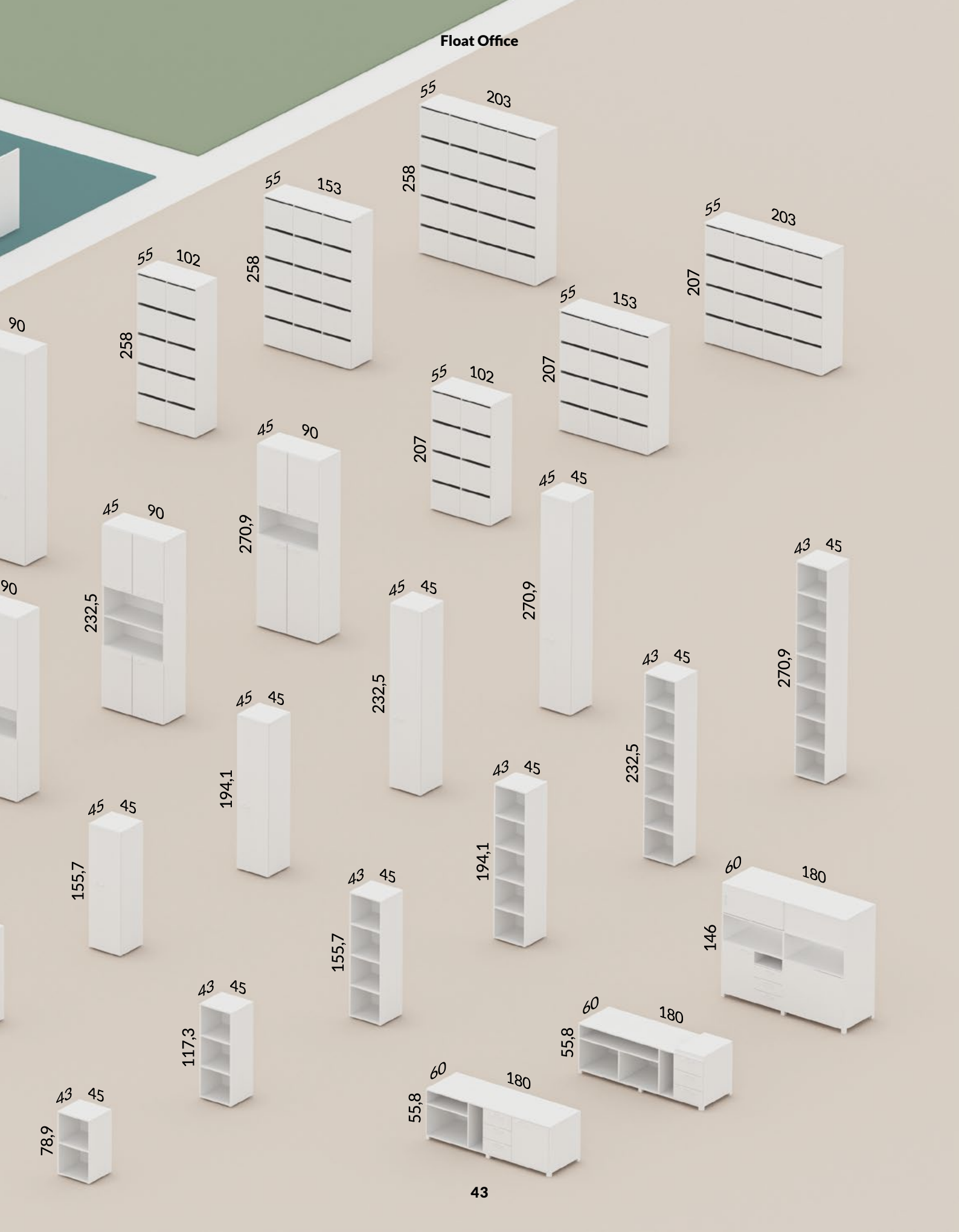

# Finishes

---

**Melaminico tinta unita**  
 Melamine solid colour  
 Mélamine  
 Melaminico liso

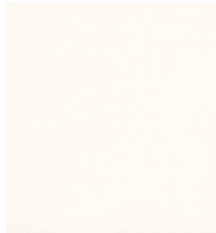

**Bianco**  
 White  
 Blanc  
 Blanco



**Antracite**  
 Anthracite  
 Anthracite  
 Antracita



**Blu**  
 Blue  
 Bleu  
 Azul



**Verde**  
 Green  
 Vert  
 Verde



**Tortora**  
 Dove grey  
 Tourterelle  
 Gris tórtola

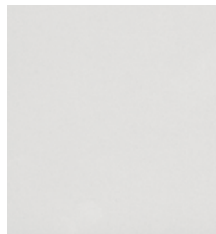

**Grigio chiaro**  
 Light grey  
 Gris clair  
 Gris claro

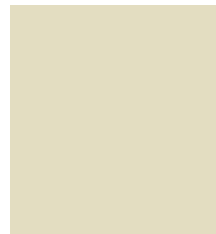

**Avorio**  
 Ivory  
 Ivoire  
 Marfil

**Melaminico decoro legno**  
 Melamine wood decor  
 Mélamine imitation bois  
 Melaminico símil madera



**Rovere chiaro**  
 Bleached oak  
 Chêne blanchi  
 Roble claro



**Noce Canaletto**  
 American Walnut  
 Noyer Amérique  
 Nogal Americano



**Wengé**  
 Wenge  
 Wengé  
 Roble Wenge

## Float Office

CDF

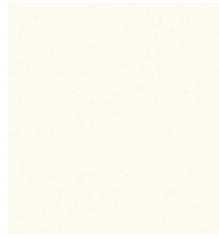

**Bianco**  
White  
Blanc  
Blanco



**Antracite**  
Anthracite  
Anthracite  
Antracita



**Blu**  
Blue  
Bleu  
Azul



**Verde**  
Green  
Vert  
Verde

**Metallo verniciato**  
Vernished metal  
Métal verni  
Metal pintado

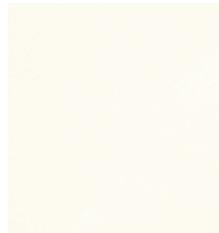

**Bianco**  
White  
Blanc  
Blanco



**Antracite**  
Anthracite  
Anthracite  
Antracita

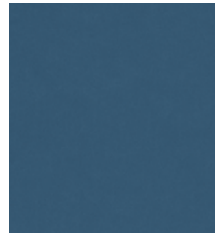

**Blu**  
Blue  
Bleu  
Azul



**Verde**  
Green  
Vert  
Verde



**Rosso**  
Red  
Rouge  
Rojo



**Grigio alluminio**  
Grey  
Gris aluminium  
Gris aluminio

**Tessuto**  
Fabryc  
Tissu  
Tejido



**Azzurro**  
Light blue  
Bleu clair  
Azul claro



**Grigio**  
Grey  
Gris  
Gris



**Verde**  
Green  
Vert  
Verde



**Viola**  
Violet  
Violet  
Violeta

# Components

---



Presca a stadio con due Schuko

Oval socket with two schuko

Prise ovale avec deux Schuko

Enchufe oval con dos Schuko



Presca tonda con una Schuko e una usb

Round socket, one schuko and one USB

Prise ronde avec une Schuko et une USB

Enchufe redondo con uno Schuko y uno USB



Torretta con tre Schuko e due usb

Turret with three schuko and two USB sockets

Tourelle avec trois Schuko et deux USB

Torreta con con tres Schuko y dos USB



Piano scorrevole per accesso all'impiantistica

Sliding top for cable access

Plan coulissant pour l'accès aux câbles

Sobre deslizando para acceder a los cables



## Float Office



Passacavi quadrato in metallo

Square metal top access

Passe-câbles carré en métal

Pasacables cuadrado de metal



Passacavi tondo in plastica

Round plastic cable port

Passe-câbles rond en plastique

Pasacables redondo plástico



Vano salita cavi con torretta

Turret sockets

Tourelle porte-prises

Compartimiento salida cables con torreta

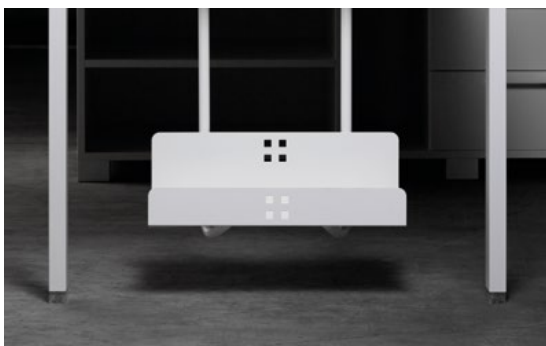

Supporto CPU

CPU support

Support UC

Soporte de CPU

archiutti | *office furniture*

Product design **Paolo Cortivo - D&T Hub con Rosetta Bortolato, Antonello Cornaglia, Masahiko Kubo**

Art direction and graphic design **Native**

3D images **Inthemiddle**

Color separation and printing **Grafiche GFP**



**Archiutti s.p.a**  
Via Postumia Ovest, 200  
31048 Olmi di  
S. Biagio di Callalta  
Treviso - Italy  
T +39 0422 7947  
F +39 0422 892304  
[www.archiutti.it](http://www.archiutti.it)  
[info@archiutti.it](mailto:info@archiutti.it)